



An ITW Company

# **IQ Power<sup>TM</sup> Control Station with Sensor Technology 2.0**

---

## **INSTALLATION AND OPERATING INSTRUCTIONS**

# TABLE OF CONTENTS

---

<b>1. SAFETY WARNINGS .....</b>	<b>1</b>
<b>2. DESCRIPTION .....</b>	<b>3</b>
<b>3. SPECIFICATIONS .....</b>	<b>4</b>
<b>4. INSTALLATION .....</b>	<b>5</b>
Mounting.....	5
Display Configuration.....	6
System Configuration.....	6
Electrical Connections.....	17
Address / Device Number .....	25
Set Up.....	27
<b>5. OPERATION .....</b>	<b>28</b>
<b>6. MAINTENANCE .....</b>	<b>33</b>
Cleaning the Control Station .....	33
<b>7. TROUBLESHOOTING .....</b>	<b>34</b>
<b>8. PARTS AND ACCESSORIES.....</b>	<b>35</b>
<b>9. WARRANTY AND SERVICE .....</b>	<b>37</b>

# 1. SAFETY WARNINGS

---

## PLEASE READ INSTRUCTIONS COMPLETELY BEFORE STARTING INSTALLATION

### ALL INSTALLATION AND TROUBLESHOOTING OPERATIONS MUST BE PERFORMED BY QUALIFIED TECHNICAL PERSONNEL

This instruction manual uses symbols to identify dangerous situations as follows:



**NOTE** – Statements identified with NOTE indicate precautions necessary to avoid potential equipment failure.



**CAUTION** – Statements identified with CAUTION indicate potential safety hazards.

**ATTENTION** – Les déclarations identifiées avec ATTENTION indiquent des dangers potentiels pour la sécurité.



**WARNING** – Statements identified with WARNING indicate potential serious injury hazards.

**AVERTISSEMENT** – Les déclarations identifiées avec AVERTISSEMENT indiquent un risque de blessures graves.



**NOTE** – This equipment must be correctly installed and properly maintained. Adhere to the following notes for safe installation and operation:

1. Read instruction manual before installing or operating equipment.
2. Only qualified service personnel are to perform installation and repairs.
3. All equipment must be properly grounded, including the machine frame to which the equipment is mounted.
4. Turn off input power to unit before connecting or disconnecting other equipment.
5. Do not operate system in close proximity to flammable liquids.
6. Do not use standard Ethernet cables with IQ Power Systems.

**CAUTION – Electrical Shock Hazard**

Disconnect input power to high voltage power supply before connecting or disconnecting static neutralizing bar or performing any maintenance to the system. Avoid touching static neutralizing bar when power supply is energized.

**ATTENTION – Risque De Choc Électrique**

Couper l'alimentation à l'alimentation électrique de haute tension avant de brancher ou de débrancher la barre de neutralisation statique ou d'effectuer un entretien au système. Évitez de toucher la barre de neutralisation statique lorsque l'alimentation électrique est sous tension.

**WARNING – Fire Hazard**

Risk of explosion if battery is replaced by an incorrect type. Dispose of used batteries according to instructions.

**AVERTISSEMENT – Risque d'incendie**

Risque d'explosion si la batterie est remplacée par un type incorrect. Jetez les piles usagées conformément aux instructions.

## 2. DESCRIPTION

---

Simco-Ion's IQ Power Control Station provides a power and communication hub for IQ Power and IQ Easy devices.

The Control Station features a universal line voltage input and will operate on 100 to 240 VAC, 50/60 Hz. It can provide power & communication for up to ten IQ Power or IQ Easy static neutralizing devices. The Control Station also allows Warning / Fault relay output connections, a Standby (STBY) input connector, Ethernet and a USB connector.

The display on the Control Station is a full color, backlit LCD with integrated touch screen. This interface allows monitoring and control of the IQ Power/IQ Easy static eliminating system. The control features four different operating modes for static eliminators; fixed, manual, Auto-Tune and CLFB (Closed-loop Feedback), and two system communication priority modes. Along with providing a convenient user interface, the Control Station allows for data logging of the system.

The Control Station also features a Fieldbus Interface that provides a factory installed module for network connectivity. A variety of fieldbus communication protocols are available, such as EtherNet/IP, PROFIBUS DP-V1, PROFINET IO, Modbus RTU and Modbus TCP by use of an HMS Industrial Network Anybus Module.

IQ Power system components, such as the BPS, HL, and HLC use 8-conductor modular cable and RJ-45 connectors for connection. IQ Power devices are typically supplied with a 7 foot modular cable assembly. Components, such as the IQ Easy Static Bar, IQ Easy Sensor Bar, and IQ Easy LP Static Bar use 5-conductor cable with M12 connectors for connection. Cables are available by calling Simco-Ion customer service (800) 203-3419 (refer to Section 8, Parts and Accessories).

### 3. SPECIFICATIONS

---

<b>Input Power</b>	100-240V~ 50/60 Hz, 4A max (IEC 320 inlet)
<b>Output Voltage</b>	24 VDC (all IQ Power and IQ Easy connectors)
<b>Device Port</b>	USB-A
<b>Network Port</b>	Ethernet
<b>Interface</b>	10.2" Color TFT LCD (backlit) with resistive touch screen
<b>Operating Temp</b>	39°C [102°F] max
<b>Mounting Slots</b>	M6 or M5 [1/4" or #10] hardware (not included)
<b>Enclosure</b>	Steel, blue epoxy powder coated
<b>Dimensions</b>	197L x 314W x 118H mm [7.75"L x 12.38"W x 4.65"H]
<b>Weight</b>	5.2 kg [11.4 lb]
<b>Compliance</b>	RoHS
<b>Approvals</b>	cULus, E11455

## 4. INSTALLATION



**NOTE** – DO NOT USE any Ethernet cables with IQ Power systems (POWER & COMM). Avoid permanent equipment damage by using only Simco-Ion modular cables. (Refer to Section 8, Parts and Accessories).

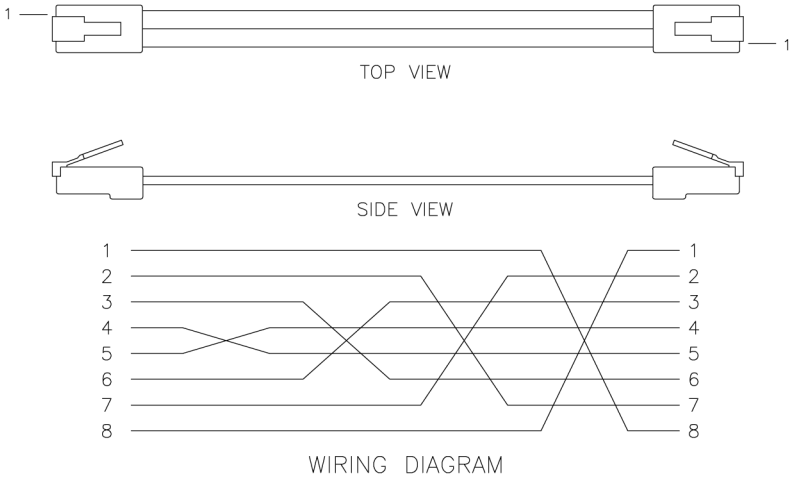

Figure 1. IQ Power Crossover Modular Cable (black)

### Mounting

Install the Control Station at a convenient place that keeps total overall cable length to a minimum.

The black modular cable supplied with unit to connect the Control Station to an IQ Power device is 2.13 meter [7 foot] long, however longer cables (not supplied) are available. Cables must be 8-conductor modular cables with RJ-45 connectors wired “crossover” (reference color: black, Figure 1).

Cables used to connect IQ Easy Static Bar, Sensor Bar or IQ Easy LP Static Bar are available in a variety of standard lengths with straight M12 connectors at the Control Station end and with a straight or right angle M12 connector at the device end.

Secure Control Station to the mounting surface using M6 or M5 [1/4” or #10] hardware (not included).

A small stylus and self-adhesive mounting clip are included with the unit. Remove the protective backing from the mounting clip and place it adjacent to, or on the side of, the Control Station.

## Display Configuration



### **CAUTION – Electrical Shock Hazard**

Disconnect input power before opening unit. Do not connect input power with unit open.

### **ATTENTION – Risque De Choc Électrique**

Mettre hors tension avant l'ouverture de l'unité. Ne rebranchez pas avec l'unité ouverte.

The Control Station may be reconfigured, placing the connector panel at the “top” of the unit, if desired (factory configuration is with the connector panel at the “bottom” of the unit). To reconfigure the unit, remove line cord from power inlet connector. Remove screws from sides of unit. Lift cover off of unit. The interface display rests on brackets built into the case. Carefully lift the interface display just off unit and rotate 180°, use care not to stress the electrical cables. Place interface display back onto brackets built into case. Check that no cables are pinched by looking through gaps at top and bottom of unit. Move cables if necessary. Replace cover and secure with screws on sides.

## System Configuration

The Control Station and related IQ Power / IQ Easy devices can be configured in a variety of ways. The range of static neutralizing and sensing equipment available allow for flexibility in meeting application requirements. When a static neutralizing device is paired with a static sensing device, the pair is considered a single device. The following figures each illustrate a fundamental configuration with specific equipment. Fundamental configurations may be combined on a system to meet the particular needs of the application.



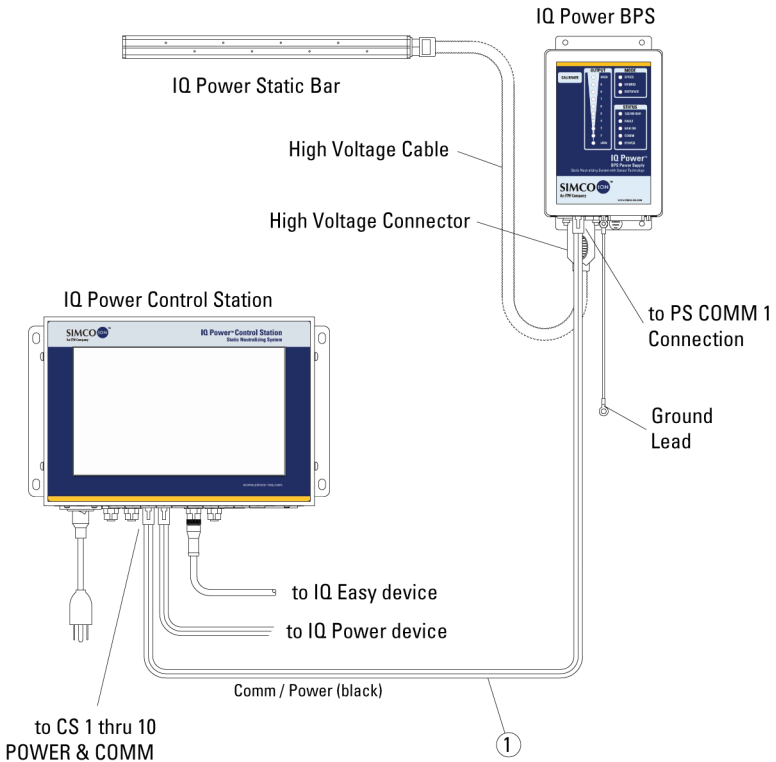

#### Comm / Data Cable Construction

① Crossover Wired   Reference color black

**DO NOT USE** any Ethernet cables.

See Section 8 Parts and Accessories for available cable lengths and part numbers.

Figure 2. IQ Power Connections (Control Station 1 thru 10 to BPS Power Supply and Bar)

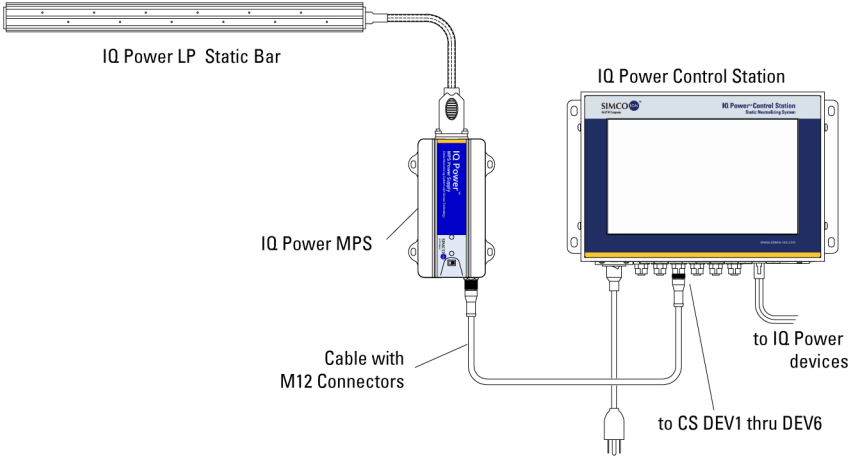

**M12 to M12 Connector Cable**

Straight (MPS End)



Control Station End

Alternate cable that may be used to connect MPS to CS 1 thru 10 POWER & COMM.

**RJ-45 to M12 Connector Alternate Cable**

Straight M12 Connector



RJ-45 Connector

See Section 8 Parts and Accessories for available cable lengths and part numbers.

Figure 3. IQ Power Connections (Control Station to MPS Power Supply)

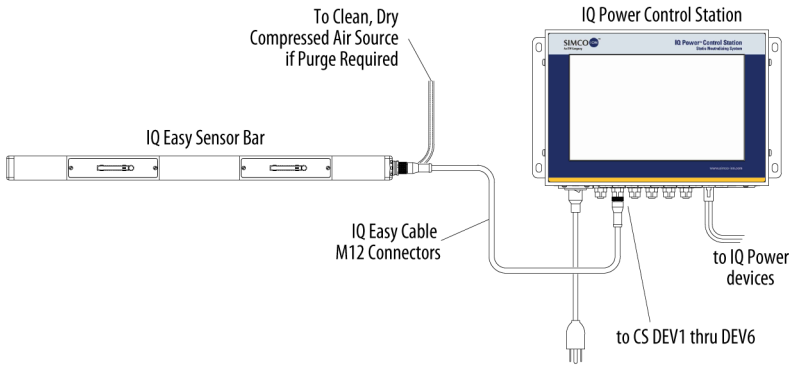

#### M12 to M12 Connector Cable Construction

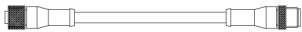
Straight (Device End)  Control Station End

Right Angle (Device End)  Control Station End

Alternate cable that may be used to connect IQ Easy devices to CS 1 thru 10 POWER & COMM.

#### RJ-45 to M12 Connector Cable Construction

Straight M12 Connector  RJ-45 Connector

Right Angle M12 Connector  RJ-45 Connector

See Section 8 Parts and Accessories for available cable lengths and part numbers.

Figure 4. IQ Power Connections (Control Station to Sensor Bar)

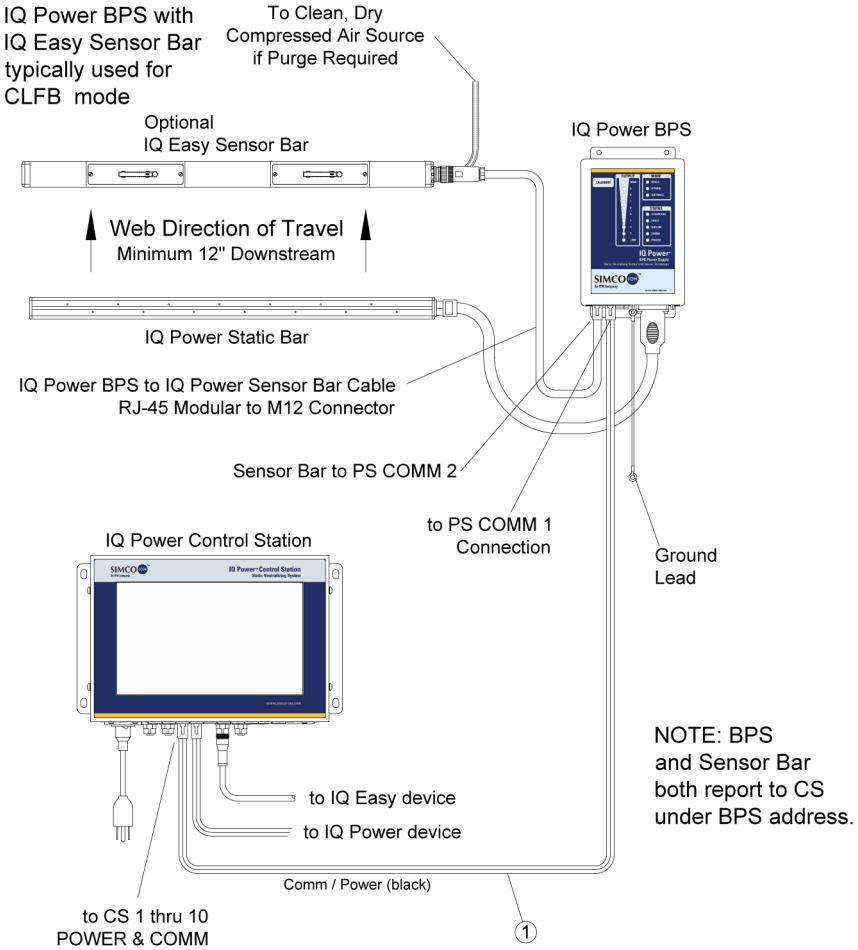

**Comm / Data Cable Construction**

① Crossover Wired Reference color black  
 DO NOT USE any Ethernet cables

**RJ-45 to M12 Connector Cable Construction**

Straight M12 Connector RJ-45 Connector

Right Angle M12 Connector RJ-45 Connector

See Section 8 Parts and Accessories for available cable lengths and part numbers.

Figure 5. IQ Power Connections (Control Station to BPS Power Supply with Options)

IQ Easy Neutralizer with IQ Easy Sensor Bar typically used for CLFB mode.

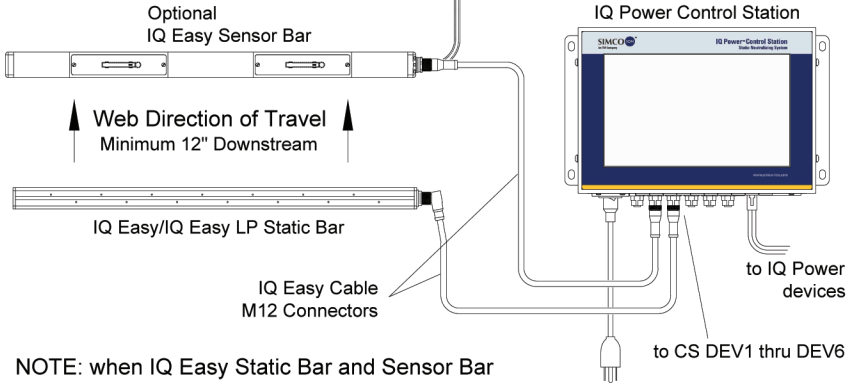

NOTE: when IQ Easy Static Bar and Sensor Bar share the same address they pair for CLFB operation.

#### M12 to M12 Connector Cable Construction

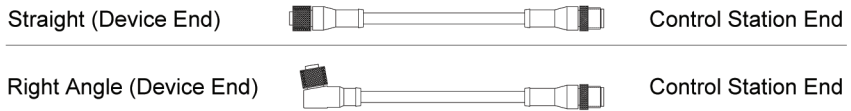

Alternate cable that may be used to connect IQ Easy devices to CS 1 thru 10 POWER & COMM.

#### RJ-45 to M12 Connector Cable Construction

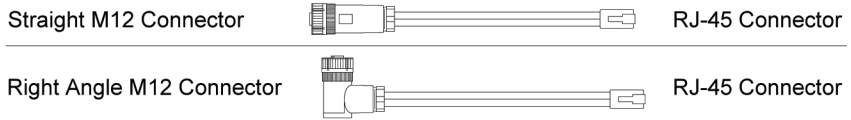

See Section 8 Parts and Accessories for available cable lengths and part numbers.

Figure 6. IQ Power Connections (Control Station to IQ Easy Sensor and Neutralizing Bar)

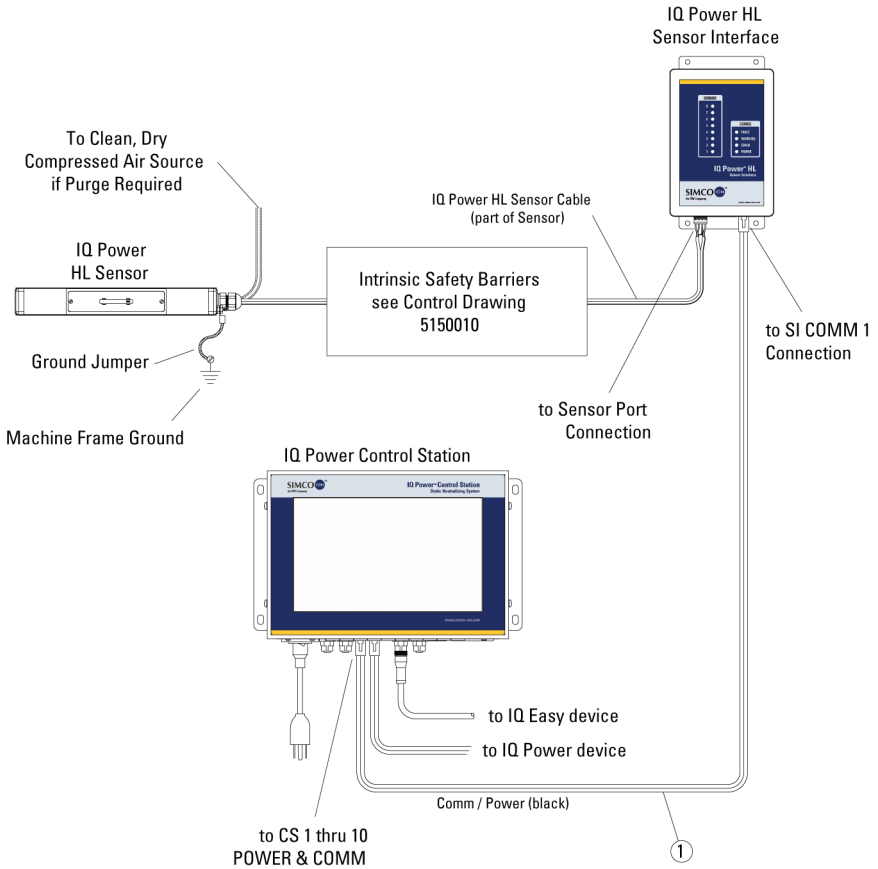

**Comm / Data Cable Construction**

① Crossover Wired   Reference color black

**DO NOT USE** any Ethernet cables.

See Section 8 Parts and Accessories for available cable lengths and part numbers.

Figure 7. IQ Power Connections (Control Station to HL Sensor Interface)

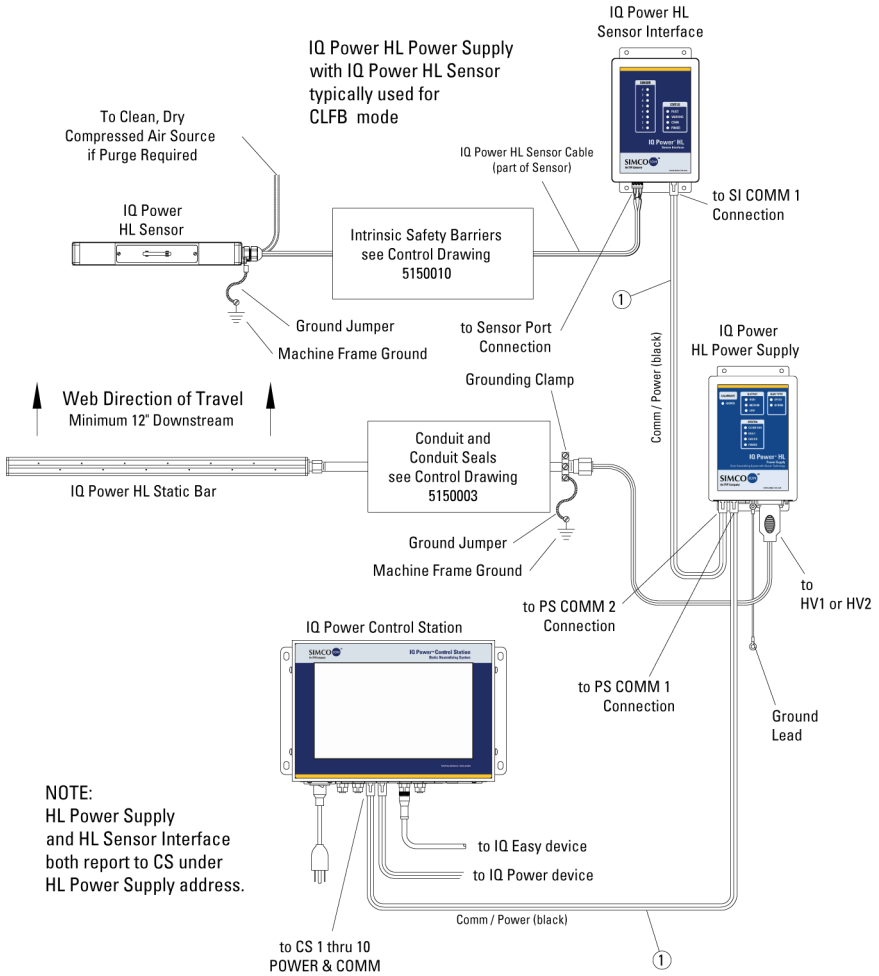

**Comm / Data Cable Construction**

① Crossover Wired   Reference color black

**DO NOT USE** any Ethernet cables.

See Section 8 Parts and Accessories for available cable lengths and part numbers.

Figure 8. IQ Power Connections (Control Station to HL Power Supply with Sensor Interface)

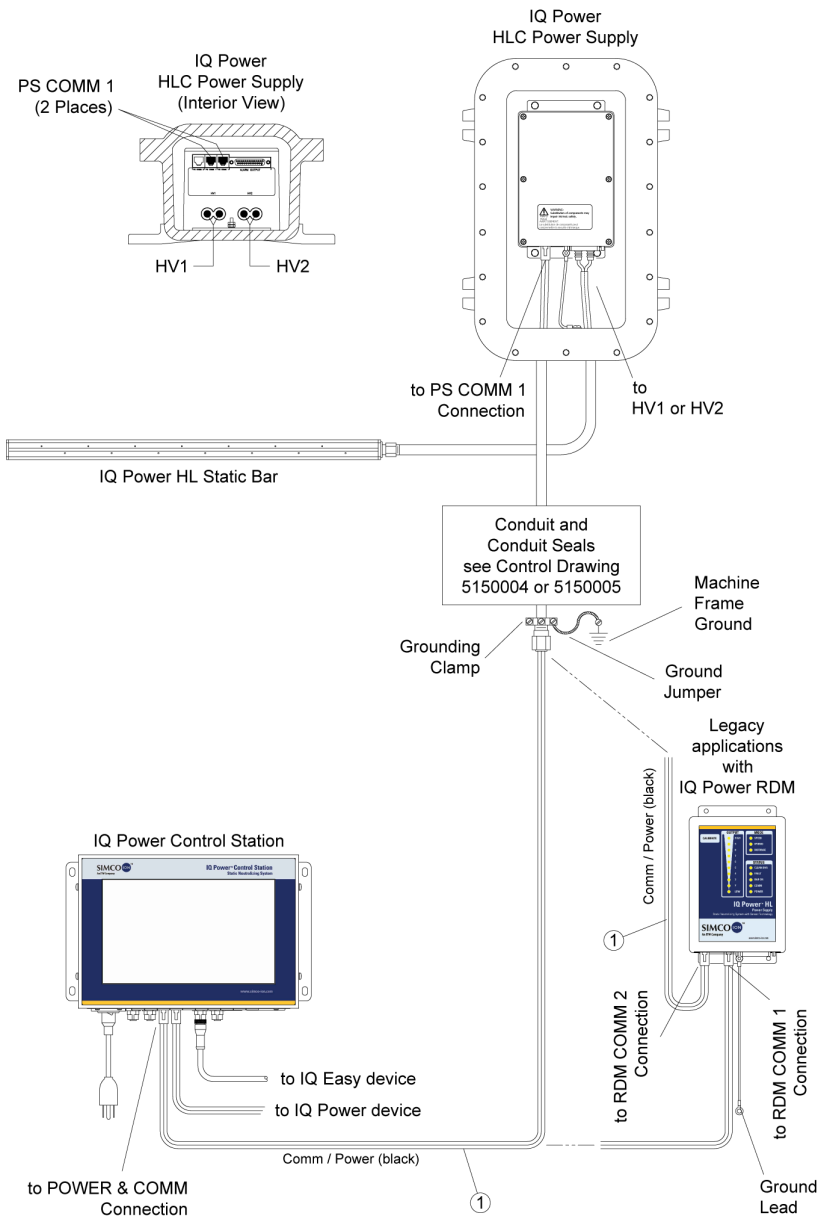

**Comm / Data Cable Construction**



- ① Crossover Wired   Reference color black  
 DO NOT USE any Ethernet cables

Figure 9. IQ Power Connections (Control Station to HLC Power Supply)



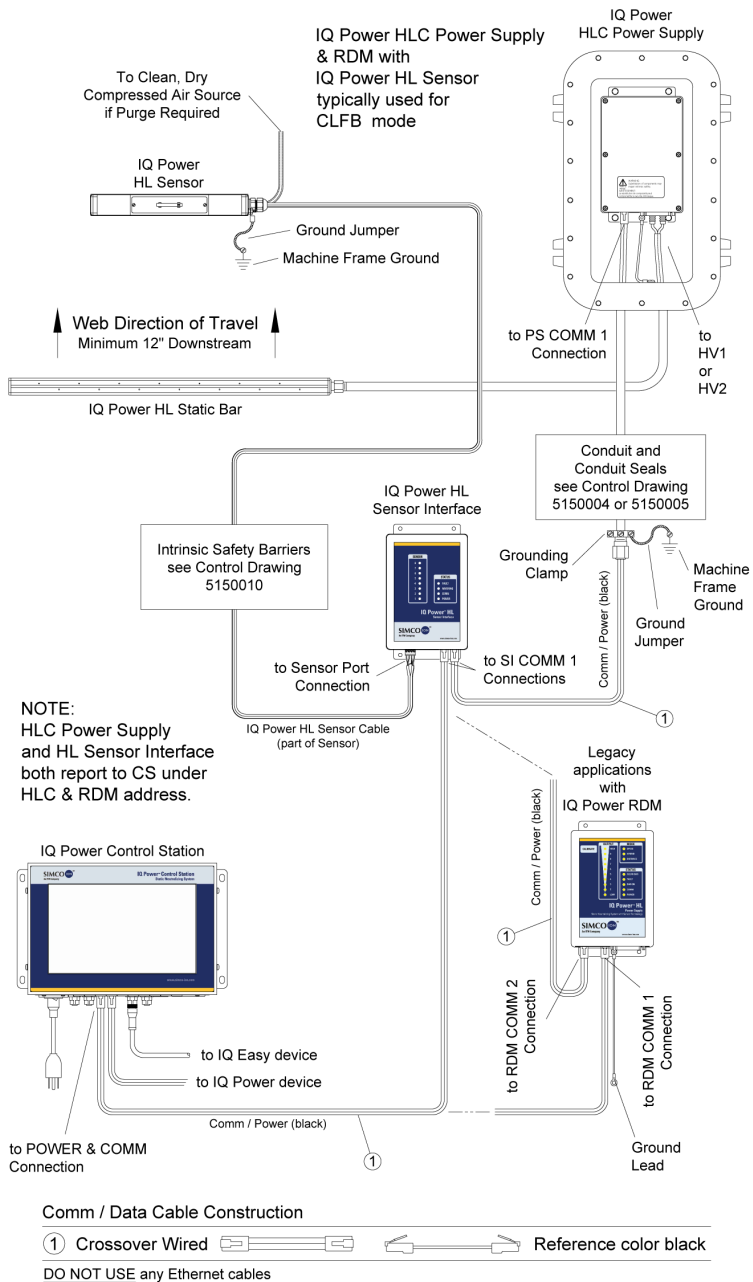
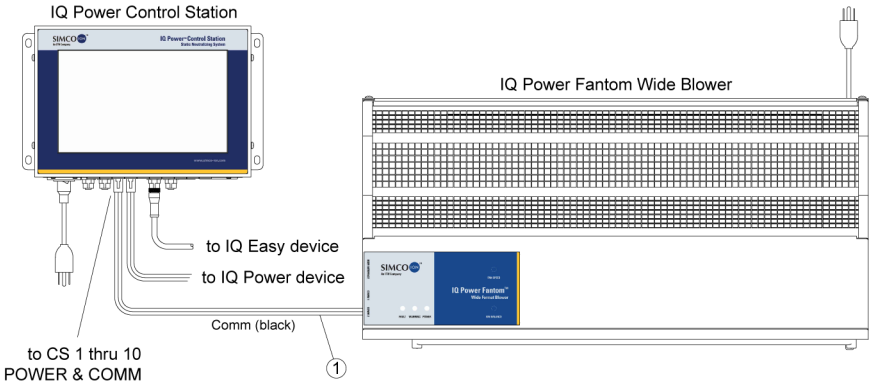

Figure 10. IQ Power Connections (Control Station to HLC Power Supply with Sensor Interface)



**Comm / Data Cable Construction**

① Crossover Wired   Reference color black

**DO NOT USE** any Ethernet cables.

See Section 8 Parts and Accessories for available cable lengths and part numbers.

Alternate cable that may be used to connect Fantom to CS DEV1 thru DEV6.  
M12 to M12 Connector Cable

Control Station End  Straight (Fantom End)

Figure 11. IQ Power Connections (Control Station to Fantom Wide Blower)



NOTE: when IQ Power Phantom and IQ Easy Sensor Bar share the same address they pair for CLFB operation.

#### Comm / Data Cable Construction

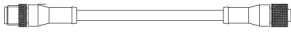
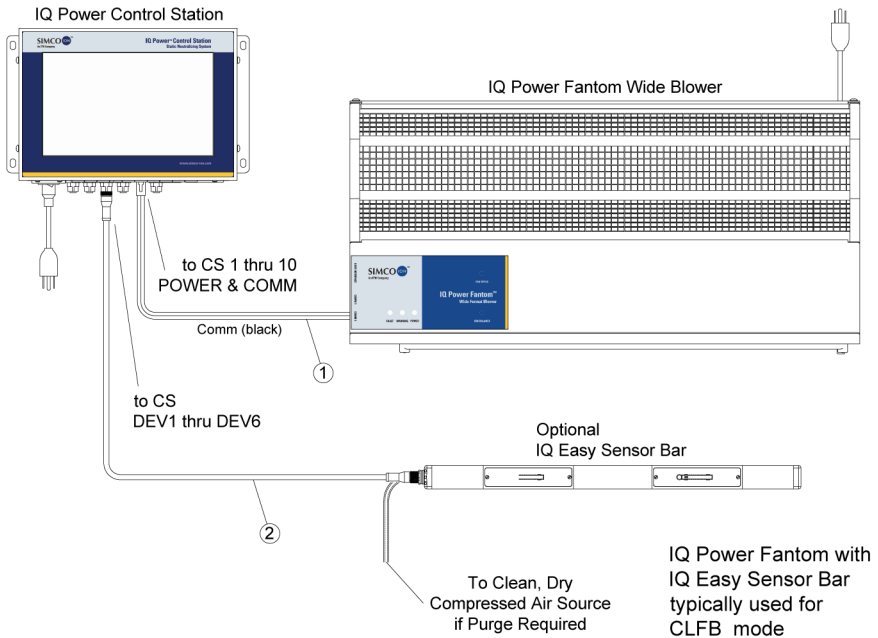
- ① Crossover Wired  Reference color black

DO NOT USE any Ethernet cables.

See Section 8 Parts and Accessories for available cable lengths and part numbers.

#### M12 to M12 Connector Cable Construction

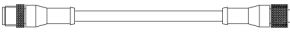
- ② Control Station End  Straight (Sensor End)

- Control Station End  Right Angle (Sensor End)

Figure 12. IQ Power Connections (Control Station to Phantom with Options)

## Electrical Connections



**NOTE** – If multiple IQ Power/IQ Easy devices are connected to the Control Station, each static neutralizer must have a unique address / device number. Addressing of devices takes place as the first step of the Set Up procedure.



**NOTE** – The maximum total number of devices plugged into “POWER & COMM” 1 thru 10 and DEV1 thru DEV6 is 10 devices. A static neutralizer is always considered one (1) device. When a Sensor Bar or HL Sensor Interface is paired with a neutralizer, the pair is considered one (1) device. A Sensor Bar or HL Sensor Interface that is not paired with a static neutralizer is considered one (1) device. Exceeding 10 devices will cause communication errors and system failure.

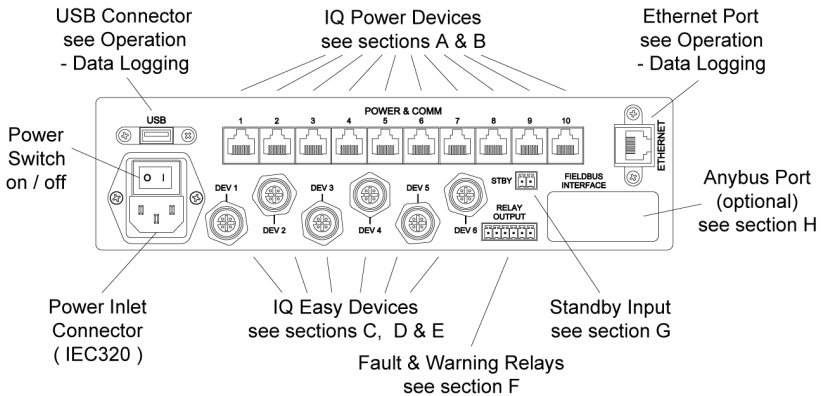

Figure 13. IQ Power Control Station Connectors

## A. Connect the IQ Power BPS / HL Power Supplies

The Control Station can supply 24 VDC power for up to ten IQ Power BPS or HL power supplies. Use the 2.13 meter [7 foot] black modular cable supplied with unit or a longer cable (not supplied) is available. Cables for the Control Station must be 8-conductor modular cables with RJ-45 connectors wired “crossover” (reference color: black, Figure 1.).

When powered from the Control Station, the “Power” switch on the BPS / HL power supply is not in-circuit, the BPS / HL will energize when the Control Station power is switched on.

The modular cable plugs into either “PS COMM 1” connector on the BPS or HL power supply.

The other end of the cable plugs into one of the ten connectors numbered 1 thru 10, labeled “POWER & COMM”.



### CAUTION – Electrical Shock Hazard

Each power supply requires its own ground lead connection to machine frame ground.

### ATTENTION – Risque De Choc Électrique

Chaque bloc d'alimentation nécessite sa propre connexion de mise à la terre au châssis de la machine.

If an IQ Easy Sensor Bar is used with the BPS (typically in CLFB - Closed-loop Feedback) the sensor bar should be plugged into connector “PS COMM 2” of that BPS power supply. This will automatically associate (pair) the sensor bar with the BPS for CLFB mode.

If an IQ Power HL Sensor is to be used with the HL power supply (typically in CLFB – Closed-loop Feedback) it is required the sensor interface (from either “SI COMM 1” connector) be plugged into connector “PS COMM 2” of that HL power supply. This will automatically associate (pair) the sensors connected to the HL power supply for CLFB mode.

See diagram for Control Station to Power Supply with Options Connections.

Modular cables should not be run parallel with the static bar high voltage cable. Route modular cables clear of moving machine parts and protect them from abrasion. Secure using nylon wire ties (not included). Do not over-tighten wire tie.

If there is an excess of modular cable, do not coil it in the vicinity of the static bar high voltage cable. If possible, cut modular cable to length and re-terminate using an RJ-45 connector installed with the same polarization as connector removed (note orientation of rib / wire color sequence to modular connector).

## **B. Connect the IQ Power HLC Power Supplies**

Cables for connection must be 8-conductor modular cable with RJ-45 connectors wired “crossover” (reference color: black, Figure 1).

Plug one end of modular cable into one of the HLC Power Supply “PS COMM 1” jacks. Run cable through rigid metal conduit to either Control Station or Sensor Interface (if used).

If the system is without Sensor Interface, plug other end of modular cable (from HLC Power Supply) into one of the “POWER & COMM” jacks on the Control Station.

If the system is with Sensor Interface, plug other end of modular cable (from HLC power supply) into one of the connections labeled “SI COMM 1” on Sensor Interface. The second modular cable plugs in to the other connector labeled “SI COMM 1” on Sensor Interface and into one of the connectors labeled “POWER & COMM” on the Control Station.

If a Sensor Interface is to be used with an HLC power supply, they will have to be “paired”. To pair an HLC power supply and Sensor Interface they must have the same Address number. This will require manually setting the Sensor Interface Address number to the same as the HLC power supply. They will appear on the Control Station as a single device with multiple tabs.

If there is an excess of modular cable, if possible, cut modular cable to length and re-terminate using an RJ-45 connector installed with the same polarization as connector removed (note orientation of rib / wire color sequence to modular connector).

See instructions included with power supply for further details.

## **C. Connect the IQ Easy or IQ Easy LP Static Neutralizing Bars**

Cables used to connect the IQ Easy or IQ Easy LP Neutralizer Bar to the Control Station have M12 connectors on both ends. Cables are available in a variety of lengths with straight or right angle connectors at the IQ Easy device end (see Parts & Accessories section). Connection is made at the Control Station to one of the six connectors labeled DEV1 thru DEV6.

Place the appropriate M12 cable connector against the connector on the device or control station and rotate the connector until the keyed connection aligns. Press the connectors together and turn the knurled coupling nut clockwise to thread it on. Finger-tighten the coupling nut until the connector is fully seated. Route cable away from any moving machine parts and secure the cable to prevent damage.

Alternate cables to connect the IQ Easy or IQ Easy LP Neutralizer Bar to the Control Station are available. These cables are available with a straight or right angle connector at the IQ Easy device end and an RJ-45 connector at the Control Station end (see Parts & Accessories section). Connection is made at the Control Station to one of the ten connectors labeled 1 thru 10 POWER & COMM.

## **D. Connect the IQ Power MPS Power Supplies**

The Control Station can supply 24 VDC power for up to ten IQ Power static eliminator power supplies. Use a pre-terminated M12 cable with straight connectors on both ends, a variety of lengths are available, see Section 8, Parts and Accessories.

When powered from the Control Station, the “Power” switch on the MPS face is not in-circuit, the MPS will energize when the Control Station power is switched on.

The M12 cable plugs into the M12 connector on the MPS power supply and into one of the six connectors numbered DEV1 thru DEV6 on the Control Station. M12 to RJ-45 cables are available and allow the MPS to be connected to the Control Station’s 10 Power & Comm ports.

See diagram for Power Supply to Control Station Connections.

The cable should not be run parallel with the static bar high voltage cable. Route the cable clear of moving machine parts and protect it from abrasion. Secure using nylon wire ties (not supplied). Do not over-tighten wire tie.

If an IQ Easy Sensor Bar is to be used with the MPS (for use in CLFB - Closed-loop Feedback) it is required that both devices have the same address / device number. This will associate (pair) the sensor bar with the MPS power supply for CLFB mode.

## **E. Connect IQ Power Fantom Wide Blower**

Two communication ports are available on the Fantom Wide Blower, COMM1 and COMM2. These communication ports allow connection to an IQ Power Control Station. Either port may be used for connection. COMM1 provides an M12 connector for round cable and COMM2 provides an RJ-45 connector for modular cable.

Where an M12 connector cable is used, connect the cable to one of the six connectors on the Control Station labeled DEV. Where an RJ-45 connector cable is used, connect the cable to one of the “POWER & COMM” jacks on the Control Station.

Connection with a Control Station allows two-way digital communication with the Fantom Wide Blower. The Control Station is able to display a variety of operating parameters and settings in the Fantom Wide Blower. If a Control Station is connected to the Fantom, but the Fantom is not powered or turned off, the Control Station will still be able to display the fixed settings in the Fantom Wide Blower.



**NOTE** – When a Fantom Wide Blower is connected to a Control Station, the Fantom still requires connection to line voltage to operate.

See instructions included with blower for further details.

## **F. Connect the IQ Easy Sensor Bars**

IQ Easy Sensor Bars connect to the IQ Power system in one of two ways.

1. Sensor Bar used with a BPS power supply:

Cables used to connect IQ Easy Sensor Bars with a BPS power supply are available in a variety of standard lengths with straight and right angle M12 connectors at the IQ Easy device end (see Parts & Accessories section).

The IQ Easy end of the cable has an M12 connector. Place the cable connector against the connector on the IQ Easy Sensor Bar and rotate the connector until the keyed connection aligns. Press the connectors together and turn the knurled coupling nut clockwise to thread it on. Finger-tighten the coupling nut until the connector is fully seated. Route cable away from any moving machine parts and secure the cable to prevent damage.

When the IQ Easy Sensor Bar is used with a BPS (typically in CLFB - Closed-loop Feedback) it is required the sensor bar be plugged into connector “PS COMM 2” of that BPS power supply. This will automatically associate (pair) the sensor bar with the BPS for CLFB mode.



**NOTE** – CLFB with a neutralizer is not possible when the sensor bar is configured in the charging mode. Ensure Sensor Mode is set to “Neutralizing” for CLFB applications.

2. Sensor Bar used standalone or with an IQ Easy/IQ Easy LP Static Neutralizing Bar/IQ Power Fantom or with electrostatic charging equipment.

Cables used to connect the IQ Easy Sensor Bar directly to the Control Station have M12 connectors on both ends. Cables are available in a variety of lengths with straight or right angle connectors at the IQ Easy device end (see Parts & Accessories section). Connection is made at the Control Station to one of the six connectors labeled DEV1 thru DEV6.

When a Sensor Bar is used in conjunction with electrostatic charging equipment, it will be necessary to manually set the Sensor Mode from “Neutralizing” to “Charging” on the Control Station. Sensor Mode–

Charging inverts the Warning and Alarm functions, so they will trigger on falling voltage (insufficient charge).

Place the appropriate M12 cable connector against the connector on the device or control station and rotate the connector until the keyed connection aligns. Press the connectors together and turn the knurled coupling nut clockwise to thread it on. Finger-tighten the coupling nut until the connector is fully seated. Route cable away from any moving machine parts and secure the cable to prevent damage.

Alternate cables to connect the IQ Easy Sensor Bar to the Control Station are available. These cables are available with a straight or right angle connector at the IQ Easy device end and an RJ-45 connector at the Control Station end (see Parts & Accessories section). Connection is made at the Control Station to one of the ten connectors labeled 1 thru 10 POWER & COMM.

### **G Connect the “FAULT” and “WARNING” relays (if used)**

These relays provide a user output for remote status detection / indication of the IQ Power system. These relays react to any Warning (yellow) or Fault (red) indicator on any device in the IQ Power system.

The connections for Relay Output are:

Terminal 1 : Fault Relay - Normal Operation

Terminal 2 : Fault Relay - Common

Terminal 3 : Fault Relay - Fault/ Power Off

Terminal 4 : Warning Relay - Fault/ Power Off

Terminal 5 : Warning Relay - Common

Terminal 6 : Warning Relay - Normal Operation

In normal operation Fault Relay Terminal 2 contact is closed / conducting with Terminal 1.

If a Fault occurs, Fault Relay Terminal 2 contact switches to Terminal 3.

When power is removed from the Control Station Terminal 2 contact switches to Terminal 3.

In normal operation Warning Relay Terminal 5 contact is closed/conducting with Terminal 6.

If a Fault occurs, Warning Relay Terminal 5 contact switches to Terminal 4.

When power is removed from the Control Station Terminal 5 contact switches to Terminal 4.

The relay contacts are rated for a maximum of 1 amp at 24 volts, with a resistive load. The connector for these relays is a 6-position pluggable header with screw terminals. The connector accepts 16-26 AWG solid or stranded wire with a strip length of 7 mm [1/4"]. To install wires into the connector, push the stripped wire fully into the square hole on the connector and tighten securely with a small flat-blade screwdriver.



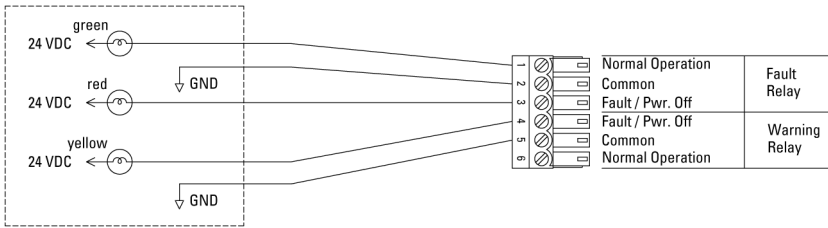

Figure 14. IQ Power Control Station Relay Output (Typical Light Tree Schematic)

In a typical light tree application:

- The green light indicates the system is powered.
- The yellow light indicates the system needs service, but is still functioning. If a sensor is part of the system, a yellow light also may indicate a Warning condition in one of the sensor voltage readings.
- The red light indicates the system has stopped functioning or is not powered. If a sensor is part of the system, a red light also may indicate a Fault condition in one of the sensor voltage readings.

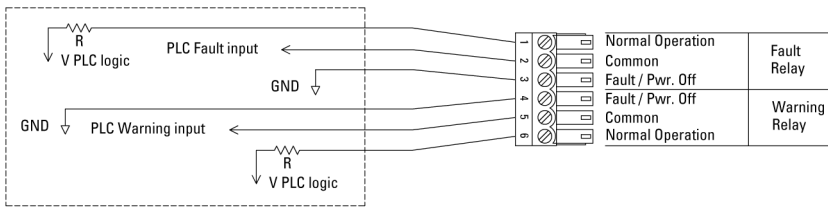

Figure 15. IQ Power Control Station Relay Output (Typical PLC Schematic)

In a typical PLC application:

- The PLC input will be held high during normal operation.
- The PLC input will be low on alarm or if the system is shut down.

## H. Connect STBY (Standby) input (if used)

This connection provides a user input for placing all neutralizers connected to the system in Standby Mode (HV off). The input is optoisolated with an operating range of 5 to 24 VDC. Application of voltage places the system in Standby Mode. When voltage is not applied the system will be in the Run Mode.

The connections for STBY (Standby) are:

- Terminal 7 : +5 to +24 VDC
- Terminal 8 : 0V (return)

If no connection to STBY (Standby) is made, the system will operate in the Run Mode.

The connector for this input a 2-position pluggable header with screw terminals. The connector accepts 16-26 AWG solid or stranded wire with a strip length of 7 mm [1/4"]. To install wires into the connector, push the stripped wire fully into the square hole on the connector and tighten securely with a small flat-blade screwdriver.

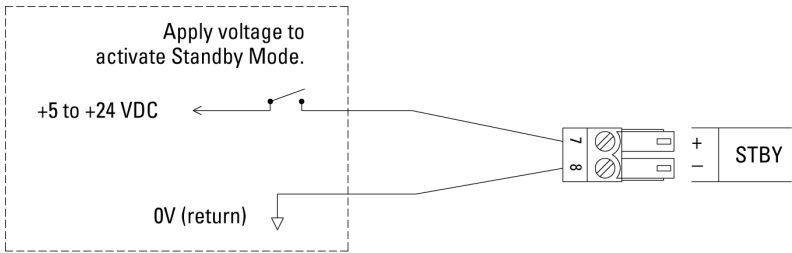

Figure 16. IQ Power Control Station STBY (Standby Schematic)

Because there may be more than one input on a system that can place it in standby mode, the operation of the STBY (Standby) input is as follows: The transition of applied voltage from low to high will place all neutralizers into Standby Mode. The transition duration should not be less than 1 second. Transitioning the voltage from high to low will place all neutralizers in Run Mode. Based on the number of devices, it typically takes 2 to 10 seconds for the change of mode to take effect. The startup setting of all devices is in the Run Mode. If the device is a Sensor Bar or HL Sensor Interface, changing STBY (Standby) voltage will have no effect.

### I. Connect Fieldbus Interface (if equipped)

The Anybus® CompactCom module is powered by, and communicates with, the IQ Power system.

- The Anybus CompactCom module typically has built-in indicator lights for power and communication. A Simco-Ion interface specification specific to the Anybus network interface chosen is supplied with the Control Station.
- Technical information for the specific Anybus module is available at the Anybus HMS Industrial Networks web site at [www.anybus.com](http://www.anybus.com), see interface specification for more details.

Control Station Fieldbus Interface List			
Anybus Module Network Interface	Anybus Model Code	Simco-Ion Kit P/N	Interface Specification
EtherNet/IP	AB6214 (AB6224)	5051872	5201294
PROFIBUS DP-V1	AB6200	5051873	5201295
PROFINET IO	AB6215	5051876	5201297
Modbus TCP	AB6213	5051877	5201298
Modbus RTU	AB6203	5051880	5201299

These modules are typically installed at the time of manufacture. Modules and related circuitry may be retrofitted at a later date provided the IQ Power Control Station is returned to the factory or authorized service center for unit modification and module installation.

Connect the Anybus CompactCom module to the PLC, data polling device or computer network using an appropriate network cable (not provided by Simco-Ion).

## Address / Device Number

The address / device number is a number 1 thru 10 on the IQ Power system. All IQ Power and IQ Easy devices are assigned an address of “1” at the factory. The address serves to differentiate devices and is also used to define association between devices.



**NOTE** – If multiple IQ Power/IQ Easy devices are connected to the Control Station, each static neutralizer must be given a unique address/ device number.

When an IQ Power BPS or HL power supply is used with a static sensor, the sensor will be plugged into “PS COMM 2” on the BPS or HL. The static sensor will automatically be assigned the same address as the BPS or HL. When an HLC power supply or IQ Easy static neutralizing bar is to be used with a static sensor, the sensor needs to be assigned the same address as the neutralizing bar. In both cases, the static sensor will appear as a tab on the neutralizer device page and be paired with the neutralizer for CLFB operation.

IQ Power BPS Power Supplies may be addressed manually (without a Control Station); however, if a Control Station is part of the system it is recommended to use the Control Station to address the BPS. IQ Easy bars and IQ Easy LP bars can only be addressed through a control station.

**Automatic address assignment** is a feature of the IQ Power system. The Control Station has the ability to automatically re-address devices connected to it, as they are connected to it. All IQ Power and IQ Easy devices are assigned an address of “1” at the factory. When a device is connected to the system a check is performed to see if the device’s address is in use. If the device is a sensor bar, it will pair with a neutralizer of the same address or be reassigned to the next sequentially available neutralizer. If the device is a neutralizer and there is already a neutralizer of the same address on the system, the neutralizer’s address will be reassigned to the next sequentially available address.



**NOTE** – When using automatic address assignment, connect equipment in the following sequence:

- First: IQ Power BPS, HL, HLC power supplies
- Second: IQ Easy neutralizing bars
- Third: IQ Easy Sensor Bars, IQ Power HL Sensor Interface
- Fourth: IQ Power MPS power supplies
- Fifth: IQ Power Phantom blowers
- Sixth: IQ Easy LP neutralizing bars

### Example 1:

Three new BPS power supplies all have address “1”. When the first BPS is plugged into the Control Station it will take address “1”. When the second BPS is plugged into the Control Station it will be reassigned address “2”. When the third BPS is plugged into the Control Station it will be assigned address “3”.

### Example 2:

Three new BPS power supplies and three new IQ Easy Sensor Bars; all have address “1”. The Sensor Bars are plugged into PS COMM 2 of their respective BPS power supplies. When the first BPS with sensor bar is plugged into the Control Station both the BPS and sensor bar will take address “1”, they will be paired. When the second BPS with sensor bar is plugged into the Control Station they will be reassigned address “2” and paired together. When the third BPS with sensor bar is plugged into the Control Station they will be assigned address “3” and paired together.

### Example 3:

Two new BPS power supplies and two new IQ Easy static neutralizing bars; all have address “1”. When the first BPS is plugged into the Control Station it will take address “1”. When the IQ Easy static bar is plugged into the Control Station it will take address “2”. When the next BPS is plugged into the Control Station it will take address “3”. When the next IQ Easy static bar is plugged into the Control Station it will take address “4”.

### Example 4:

Two IQ Easy static neutralizing bars and two new IQ Easy Sensor Bars; all have address “1”. When the first IQ Easy static bar is plugged into the Control Station it will take address “1”. When the IQ Easy Sensor Bar is plugged into the Control Station it will be paired with IQ Easy static bar and have address “1”. When the second IQ Easy static bar is plugged into the Control Station it will take address “2”. When the next IQ Easy Sensor Bar is plugged into the Control Station it will be paired with the available IQ Easy static bar and have address “2”.



**NOTE** – Legacy BPS or HL power supplies (not bearing “with Sensor Technology” on their labeling) will not support connection of sensor or automatically re-address as described above.



**NOTE** – On the connector panel of the Control Station the connectors are numbered for reference but the numbering on the connector panel is not associated with the device address.

**The address / device number may be changed at any time** through the device page. It may be necessary to tap on a tab and/or the Page arrow to locate the Device Address. The device address will be found listed as “BPS Address”, “IQ Easy Bar Address”, “Sensor Bar Address”, etc. Tapping the pencil icon next to the address will open a prompt for a password. The default password for set-up is “PASSWORD”. Tapping the desired number changes the device address for the device.

Unassigned device addresses will appear on the Control Station display as a blank gray icon.



If a device is unplugged or disconnected for any reason the Control Station software will need to be refreshed. This can be done by turning the power off then on, or by tapping the refresh icon (small spiral arrow) at the bottom right of the display. Failure to refresh the software before reconnecting a device may result in unwanted reassignment of the device address when it is plugged back in.

## Set Up

### Prepare for set up by temporarily unplugging all devices at the Control Station.



**NOTE** – Before switching on the Control Station; ensure all BPS units in the system are properly grounded.

**Connect AC power** (make sure the power switch on Control Station is in the off (“0”) position). The Control Station has universal line voltage input that accepts line voltage from 100 to 240 VAC, 50/60 Hz. The unit is supplied with line cords suitable for use with 120 and 230 volt operation in North America. The line cord also provides electrical ground to the Control Station. Check electrical ground integrity in the line voltage receptacle used for the Control Station. This ground must not be defeated.

**Perform setup by assigning address.** Turn Control Station power switch (located near the power inlet) to the on (“I”) position. Allow IQ Power Control Station software to start and display the home page. C connect equipment in the following sequence:

Connect equipment in the following sequence:

First: IQ Power BPS, HL, HLC power supplies

Second: IQ Easy neutralizing bars

Third: IQ Easy Sensor Bars, IQ Power HL Sensor Interface

Fourth: IQ Power MPS power supplies

Fifth: IQ Power Fantom blowers

Sixth: IQ Easy LP neutralizing bars

While setting up the system the devices will be assigned “DEVICE\_NAME\_1”, “DEVICE\_NAME\_2”, etc. This Device Name may be edited on the device page to a user chosen description (14 character maximum). The Device Name will appear at the top of the icon for the device on the system home screen.

If a neutralizing device (BPS, HL, HLC, IQ Easy static bar or Fantom blower) does not assume a correct address, re-address the device through the device page. If a sensor bar does not “pair” with the correct neutralizer, re-address the sensor bar through the device page, sensor tab. Assign the sensor the address of the neutralizer it is desired to be paired with.

If it becomes necessary to identify a neutralizer device from the Control Station, the Device Locator Utility may be used. This utility is typically located on the last page for the device. Activating the Device Locator Utility causes the LED indicators on the device to flicker for approximately 10 seconds allowing a user to identify the physical location of the device.

## 5. OPERATION

---



**NOTE** – Before switching on the Control Station; ensure all BPS, HL and HLC units in the system are properly grounded.

- A. BPS, HL, HLC static neutralizer power supplies connected to a Control Station will energize regardless of power switch setting.
- B. Switch the Control Station power switch (located near the power inlet) to on (“I”).
- C.  The Control Station will start by displaying the Home Page. In the upper portion of the display is an icon for System Settings (a gear). Tapping on the gear icon opens the System Settings page and allows adjustment of system operating parameters and operating parameters that can be applied to all devices in the system. For example:
  - Device Name for the system
  - Add'l Info
  - Data Log - On/Off
  - Data Log Time Base (selectable interval)
  - Up Time - total run time for system
  - Panel Mode (where more than one display panel is on the system)
  - Legacy Mode for use with earlier devices
  - Password (to change)
  - Software Version
  - System Information Utility/Fieldbus Module Utility

To adjust settings, tap the pencil icon to the right of the setting. The settings are password protected. From the factory, the default password is “PASSWORD”.

**Changing the password:** Tap on the pencil icon for Password in the System Settings page. Enter the current password to proceed. A prompt will appear to set a new password. The maximum password length is 14 characters

**Resetting the password:** If the password is forgotten, enter “2257” when prompted for the password. This will reset the password to the factory default of “PASSWORD”.

**System Information Utility:** There are two diagnostic screens available, the System Information Utility and the Fieldbus Module Utility (where a fieldbus is installed). Both screens provide a “snapshot” that can be used for diagnostic purposes. The

System Information Utility provides a comprehensive list of devices connected to the system, their firmware version number and accumulated run time. The Fieldbus Module Utility displays, where a fieldbus is installed, the contents of the fieldbus data buffer and other system information typically found in the fieldbus output. Both utilities are provided in the event troubleshooting is needed. If factory assistance required, a simple photograph (.jpg) of the diagnostic screen(s) will expedite troubleshooting.

**Lock Screen** is a function that may be activated on any screen. In normal operation, the Control Station display will automatically return to the home screen after a brief period of time. Lock screen enables the operator to disable the automatic return to home screen. To enable lock screen, press on any inactive area of the screen and hold until a double beep occurs and the Lock Screen icon appears. To leave lock screen, tap on any inactive area of the screen, the Lock Screen icon will disappear and automatic return to the home screen is enabled.

**Panel Mode** is a setting used where there is more than one user interface display panel on the system. With a single display panel on the system, Panel Mode will default to “Primary”. If other panels are installed on the system, the other panels should be set to “Secondary”

**Legacy Mode** is a setting used to enable digital communication with earlier IQ Power and IQ Easy devices. If an earlier device is connected to the control station, the mode will automatically detect it and lock on “Legacy Mode”. Legacy Mode slows the digital communication and may be used if the digital communication is troublesome, for example, in an area of high electrical interference

**Wireless Mode** is a setting required when the system includes an IQ Power Wireless Link. Wireless Mode sets digital communications to ensure reliable wireless operation. If Wireless Mode is not available, Legacy Mode should be set on. If neither mode is available, no adjustment is required.

**Data Logging:** The data log function works in conjunction with a flash drive plugged into the USB port. When data logging is enabled, the Control Station will create a unique CSV (Comma Separated Value) file for each device connected. These files are updated by appending the data at intervals set in the Data Log Time Base. These files can be opened with a spreadsheet program like Excel.

The logged data for the Control Station may also be accessed via local area network. If the Control Station is connected to the network by its Ethernet connector, the data may be accessed using a web browser and FTP function. The factory default IP Address is 192.168.127.254 however this address may be changed.

Data logging is indicated on the Control Station with a line at the bottom of the display “Data Log File” and a date / time stamp.

D. The IP Address may be accessed through the Control Station operating system.



**Check or change the IP Address:** must be done from in the operating system. From the Home Page tap on the small computer icon at the bottom left of the display, then tap on “yes” to “Close Control Station Software”.

This will take you to the display system environment.

1. Tap the “Input Panel” icon on the extreme right hand side of the Task Bar.
2. Tap “LargeKB” to activate the virtual keyboard.
3. Tap “Start”, “Network and Dial-up Connections”
4. Drag the virtual keyboard to the center of the screen, if necessary.
5. Double tap the “DM91SA1” icon.
6. A dialog box will appear with the IP Address and Subnet Mask.
7. Enter the desired information and tap “OK” on the dialog box.
8. Turn the Control Station power off, then back on to restart the IQ Power system.

E. The Home Page contains a date / time display in the upper area of the display. The incrementing of seconds in this display indicates the software is active and running.



**Setting Time & Date:** if it becomes necessary to reset the time or date, the system clock will have to be accessed. The use of a stylus or USB mouse is recommended for this procedure. From the Home Page tap on the small computer icon at the bottom left of the display, then tap on “yes” to “Close Control Station Software”. This will take you to the display system environment.

1. Double tap the clock in the system task bar.
2. Check and set the date, tap “Apply”.
3. Check and set the time zone, tap “Apply”.
4. Check and set the time, tap “Apply”.
5. Tap on “OK”.
6. Turn the Control Station power off, then back on to restart the IQ Power system.

F. The Home Page contains an icon for each device connected to it. There can be up to 10 of these icons displayed. Tapping on the icon opens a Device Page for the specific device.

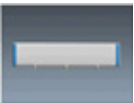

Icon typically used for an IQ Power BPS, MPS, HL or HLC power supply.



Icon typically used for an IQ Easy Sensor Bar or IQ Power HL Sensor Interface.





Icon typically used for IQ Power BPS, HL or HLC paired with a static sensor.

Ex: IQ Power BPS paired with an IQ Easy Sensor Bar.

Ex: IQ Power HL paired with an IQ Power HL Sensor Interface.



Icon typically used for an IQ Easy Static Neutralizing Bar.



Icon typically used for an IQ Easy Static Neutralizing Bar paired with an IQ Easy Sensor Bar.



Icon typically used for an IQ Easy LP Static Neutralizing Bar



Icon typically used for an IQ Easy LP Static Neutralizing Bar paired with an IQ Easy Sensor Bar



Icon typically used for IQ Power Fantom wide blower.



Icon typically used for an IQ Power Fantom wide blower paired with an IQ Easy Sensor Bar.

The icons will display with a background color that corresponds to the device status:

Gray - inactivity

No device shown - no device was found at the address

Neutralizer shown - HV is turned off / standby mode

Green - normal operating status

Yellow - warning status

Neutralizer - cleaning is needed

Sensor - voltage detected over warning setpoint

Red - alarm status

Neutralizer - fault alarm / communication failure

Sensor - voltage detected over alarm setpoint / fault alarm / communication failure

If an IQ Easy device that is not compatible is plugged into the system the device icon will be red and bear the message “Upgrade Required”. The device will be powered and operating in a stand-alone mode. Upgrading a device is available at the factory, contact Simco-Ion customer service at (800) 203-3419.

The Device Page for a static neutralizer will typically open to a Summary tab highlighting a variety of information about the neutralizing equipment. Information is not editable from the summary tab.

#### Typical Summary Tab

- Device Name
- Ion Output
- Operating Mode
- Ion Current
- Balance
- Web Speed
- Overall Sensor Average (if paired)
- Mounting Distance (Auto-Tune)
- Feedback Sensor Average (if paired)
- Sensors for Feedback (if paired)

The Device Page for a static neutralizer includes tabs for the Neutralizer and Sensor (if paired). These tabs typically offer more detailed information and the ability to edit or make adjustments to settings. Neutralizer and sensor tabs typically contain more than one page, the pages being accessed by tapping the arrow head of “Page x/x” in the upper right of the display.

#### Typical Neutralizer Tab

- Device Name - editable, 14 characters
- Device/Bar Type - fixed description
- Operation Mode - selectable: Fixed / Auto-Tune / CLFB / Manual





**NOTE** – In CLFB, communication System Priority will automatically set to “Neutralizer.”

- Bar HV - selectable: on / off (run / standby) neutralizers power-up in the on /run mode
- Ion Output - relative output in percentage and ionizer output current, positive and negative, in microamps
- Balance - Fixed = 50/50, Auto-Tune / CLFB system adjusts value, Manual user adjusts value
- Mounting Distance - selectable, bar type dependent
- Device Address - editable, address / device number
- Device Version - firmware version
- Device Locator Utility - utility to briefly flash device LEDs
- Alarm Test Utility - utility to briefly set device alarms for testing

The Device Page for a stand-alone (not paired) sensor bar or sensor interface is typically a sensor tab. The tab offers detailed information and the ability to edit or make adjustments to settings. A sensor tab typically contains more than one page, the pages being accessed by tapping the arrow head of “Page x/x” in the upper right of the display.

## Typical Sensor Tab

- Device Name - editable, 14 characters
- Device Address - editable, address / device number
- Overall Average - averaged voltage from all sensor modules
- Feedback Average - averaged voltage from sensor modules selected for feedback (if paired)
- Sensors for Feedback - selectable, sensor modules selected for feedback (if paired)
- Sensor Quantity - 1 to 8 depending on quantity of sensors on bar
- Mounting Distance - selectable, controls voltage range
- Sensor Mode - Allows sensor to be set for neutralizing or electrostatic charging applications
- System Priority - (Sensor Technology 2.0) allows setting digital communication to prioritize neutralizer data for typical operation or to prioritize sensor data for applications where response to static charge levels is critical
- Warning Setpoint - adjustable, activates bar yellow LED, set warning output
- Alarm Setpoint - adjustable, activates bar red LED, sets alarm output
- Web Voltage Sensor 1,2,3... - voltage reported by given sensor module
- Calibration Date / Firmware 1,2,3... - calibration and firmware for a given sensor module

- G.  The Device Pages all contain a Home icon in the upper right corner. Tapping this icon takes the user to the system Home Page.
- H.   If a yellow warning or red alarm icon appears on any page, the icon may be tapped for a descriptive pop-up of the warning or alarm.

## 6. MAINTENANCE

---



**NOTE** – Turn off power to the Control Station before performing any maintenance.

### Cleaning the Control Station

Clean the Control Station using a lint-free wiper moistened (but not saturated) with a 50/50 mix of isopropyl alcohol and water. Avoid soaking the touch screen display and electrical connectors. Allow the control station to dry completely before applying power.

## 7. TROUBLESHOOTING



**NOTE** – Only qualified service personnel are to perform troubleshooting tasks.



### **CAUTION – Electrical Shock Hazard**

Do not troubleshoot high voltage components with power supply energized. Disconnect input power before troubleshooting. Troubleshooting must be performed by a qualified service person.

### **ATTENTION – Risque De Choc Électrique**

Ne pas faire de dépannage des composantes de haute tension avec alimentation sous tension. Couper l'alimentation électrique avant le dépannage. Le dépannage doit être effectué par une personne qualifiée.

PROBLEM	CAUSE	SOLUTION
Control Station not working; touch screen dark, not illuminated	Power not on at Control Station	Turn on power switch at power entry module
	Line voltage not supplied	Check line voltage and connections.
Control Station not working; touch screen lit, display “frozen”	Software needs reset	Turn Control Station off, wait 10 seconds, turn Control Station on
	Touchscreen contaminated	Examine touchscreen for build-up of debris that would simulate an input, carefully clean debris off touchscreen
	Touchscreen damage	Examine touchscreen for damage that would simulate an input (cuts, gouges, deformities in display area), replace touchscreen
Control Station not delivering power to device	Poor electrical connections	Check connections of device cables at device and Control Station. Check condition of cables
	Internal fuse blown	Replace fuse, see below
Communications failure	Incorrectly wired modular cable (check against cable illustrations in Installation section)	Replace or repair modular cable
	Device cable routed near HV cable	Move and secure device cable away from HV cable



**NOTE** – Device power and communication ports are protected by internal fuses identified as F1-F10 on the RJ-45 backplane circuit board and F1-F6 on the M12 backplane circuit board. The fuses are replaceable only by qualified service personnel. Use radial-type fuses rated 230 VAC, 2.5 A only (such as Bel Fuse MRT-2.5 or equivalent).

## 8. PARTS AND ACCESSORIES

Part Description	Part Number
Control Station (100-240 VAC input)	4015868
Remote Mount Control Station (100-240 VAC input)	4016669
Line Cord, North American/Japan 120/100 VAC	4106272
Line Cord, North American 230 VAC	4106274
Connector Kit, Relay Output / STBY	5051855
Mounting Kit, Under Panel (2 brackets to mount Control Station beneath a panel)	5051898
Mounting Kit, Remote Under Panel (hardware to separate display from Control Station and mount display (only) beneath a panel)	5051901
Modular Cable (RJ-45 to RJ-45, IQ Power 8-conductor, crossover wired) for use between Control Station and IQ Power BPS / HL / RDM "COMM 1" DO NOT USE any Ethernet Cables (see Figure 1)	
0.91 meter [3 foot] black	4520785
2.13 meter [7 foot] black	4520786
4.27 meter [14 foot] black	4520787
7.62 meter [25 foot] black	4520784
15.24 meter [50 foot] black	4520844
22.86 meter [75 foot] black	4520845
30.48 meter [100 foot] black	4520832
Cable (RJ-45 to straight M12 connector) IQ Power BPS to IQ Easy Sensor Bar with straight connector at Sensor Bar end	
4.57meter [15 foot] Straight M12 Connector	5051840
9.14 meter [30 foot] Straight M12 Connector	5051844
Cable (RJ-45 to right angle M12 connector) IQ Power BPS to IQ Easy Sensor Bar with right angle connector at Sensor Bar end	
4.57 meter [15 foot] Right Angle M12 Connector	5051841
9.14 meter [30 foot] Right Angle M12 Connector	5051845
Cable (IQ Easy M12 connectors at both ends) for use between Control Station and IQ Easy, IQ Power MPS or Fantom with straight connector at device end	
1.5 meter [4.9 foot] Straight / Straight M12 Connector	5051939
5 meter [16.4 foot] Straight / Straight M12 Connector	5051791
10 meter [32.8 foot] Straight / Straight M12 Connector	5051792
20 meter [65.6 foot] Straight / Straight M12 Connector	5051793
30 meter [98.4 foot] Straight / Straight M12 Connector	5051794

Cable (IQ Easy M12 connectors at both ends) for use between Control Station and IQ Easy with right angle connector at IQ Easy device end	
5 meter [16.4 foot] Straight / Right Angle M12 Connector	5051796
10 meter [32.8 foot] Straight / Right Angle M12 Connector	5051797
20 meter [65.6 foot] Straight / Right Angle M12 Connector	5051798
30 meter [98.4 foot] Straight / Right Angle M12 Connector	5051799
Fieldbus Interface Kits (installed at factory only)	
EtherNet/IP Anybus Model AB6214	5051872
PROFIBUS DP-V1 Anybus Model AB6200	5051873
PROFINET IO Anybus Model AB6215	5051876
Modbus TCP Anybus Model AB6213	5051877
Modbus RTU Anybus Model AB6203	5051880

## **9. WARRANTY AND SERVICE**

---

This product has been carefully tested at the factory and is warranted to be free from any defects in materials or workmanship. Simco Ion will, under this warranty, repair or replace any equipment which proves, upon our examination, to have become defective within one year from the date of purchase.

The equipment being returned under warranty should be shipped by the purchaser to Simco-Ion, 2257 North Penn Road, Hatfield, PA 19440, transportation prepaid and insured for its replacement cost. Prior to returning any goods for any reason, contact Simco-Ion Customer Service at 215-822-6401 for a Return Authorization Number (RMA). This number must accompany all returned items.

This warranty does not apply when the equipment has been tampered with, misused, improperly installed, altered, has received damage through abuse, carelessness, accident, connection to improper line voltage, or has been serviced by anyone other than an authorized factory representative.

The warranty does not apply when Simco-Ion parts and equipment have been energized by other than the appropriate Simco-Ion power supply or generator, or when a Simco-Ion power supply or generator has been used to energize other than Simco-Ion parts and equipment. Simco-Ion makes no warranty, expressed or implied, nor accepts any obligation, liabilities, or responsibility in connection with the use of this product other than the repair or replacement of parts stated herein.

Information in this publication supersedes that in all previous published material. Specifications are subject to change without notice.

**Simco-Ion**

2257 North Penn Road  
Hatfield, PA 19440

(215) 822-6401

(800) 203-3419

[www.simco-ion.com](http://www.simco-ion.com)

[customerservice@simco-ion.com](mailto:customerservice@simco-ion.com)

© 2022 Simco-Ion. Printed in the U.S.A.